

FORI ESAGONALI
M5 DIAM.7,2MM

FORI ESAGONALI
M5 DIAM.7,2MM

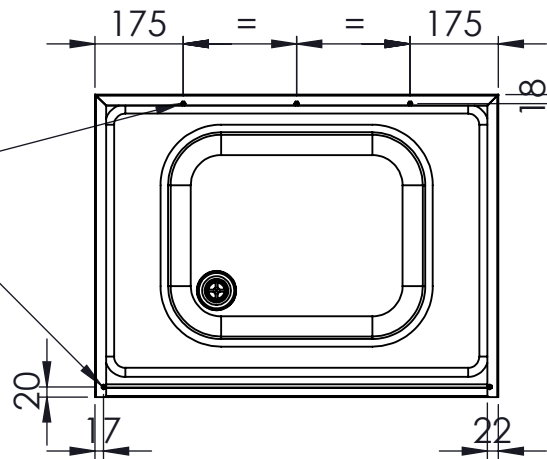

DISEGNATO	
DATA	10/01/2024
PESO	10071.20

CODICE: **LW00**



CONFIGURAZIONE: **L:800 P:600**

SCALA:1:15

A4

FOGLIO 1 DI 1